

IT DALI 110/120-240/1A0 P7

ICUTRONIC - DALI (AstroDIM) IP67 | Constant current LED drivers



Product family features

- Available with different wattage: 20 W, 40 W, 75 W, 110 W, 150 W, 200 W, 240 W
- AstroDim functionality
- Constant Lumen Output (CLO)
- DALI-2 certified (Part 251, 252, 253)
- DALI dimming (min.10%)
- Output current range 350...1050 mA
- Supply voltage: 120...240 V

Product family benefits

- Versatile DALI driver due to flexible output characteristic
- Fully programmable via T4T software (DALI / AstroDIM / Constant Lumen)
- Lifetime: up to 100,000 h (depending on T_c temperature, max. 10 % failure rate)
- High efficiency
- High surge protection: up to 10 kV
- IP rating: IP67 (Independent installation)
- High efficiency and reliability
- 5 years guarantee



Areas of application

- Industry lighting
- Street and urban lighting
- Suitable for use in outdoor luminaires of protection class I and II

Technical data

Electrical data

Max. ECG no. on circuit breaker 10 A (B)	9 ¹⁾
Max. ECG no. on circuit breaker 16 A (B)	14 ¹⁾
Maximum output power	110 W
Minimum output current	70 mA ²⁾
Nominal output current	350...1050 mA ³⁾
Nominal output power	110 W
Nominal output voltage	75...157 V
Nominal input voltage	120...240 V
Input voltage AC	120...264 V
Device power loss	9.0 W ⁴⁾
Efficiency in full-load	93 % ⁵⁾
Inrush current	66 A ⁶⁾
Power factor λ	0.84C...0.99 ⁷⁾
Mains frequency	50/60 Hz
Surge capability (L-N)	6 kV
Surge capability (L/N-Ground)	10 kV ⁸⁾
U-OUT (working voltage)	180 V
Output current tolerance	±5 %
Output ripple current (100 Hz)	+/- 5 % ⁹⁾
Total harmonic distortion	< 10 % ¹⁰⁾
Default output current	700 mA

1) Type B

2) Physical Minimum Dimming Current

3) Default 700 mA; 200...1050 mA adjustable

4) At Full load, 230 V, 50 Hz

5) at 230 V, 50 Hz

6) Max, $t_h = 145 \mu s @ 50 \% I_{pk}$

7) Full load at 230 V / 50 Hz

8) L - N acc to EN 61547 (>15 pulses) / L/N - PE acc to EN 61547 (>15 pulses)

9) Ripple / average @ 100 Hz

10) At full load, 230 V, 50 Hz / see graphs

Typical Power Factor v Load

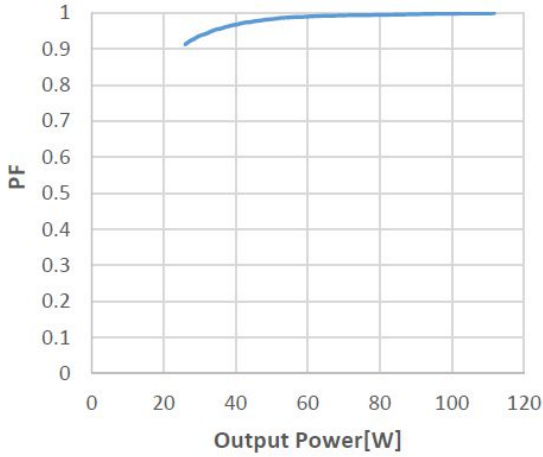

Operating Window

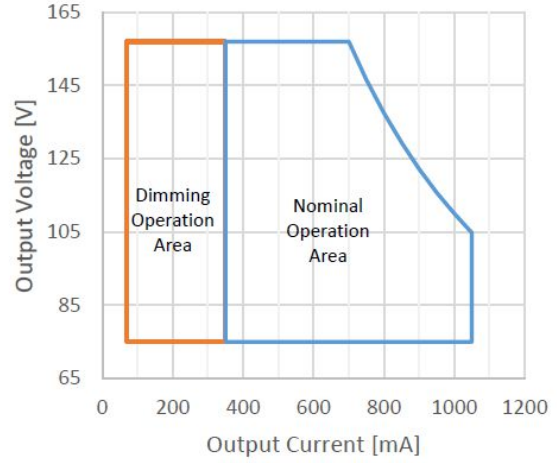

IT DALI 110 120 240 1A0 P7 Typical Power Factor vs. Load

IT DALI 110 120 240 1A0 P7 Operating Window

Typical THD v Load

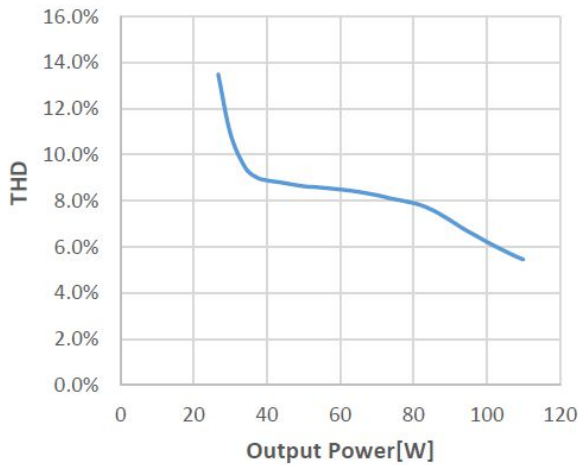

Typical THD v Load

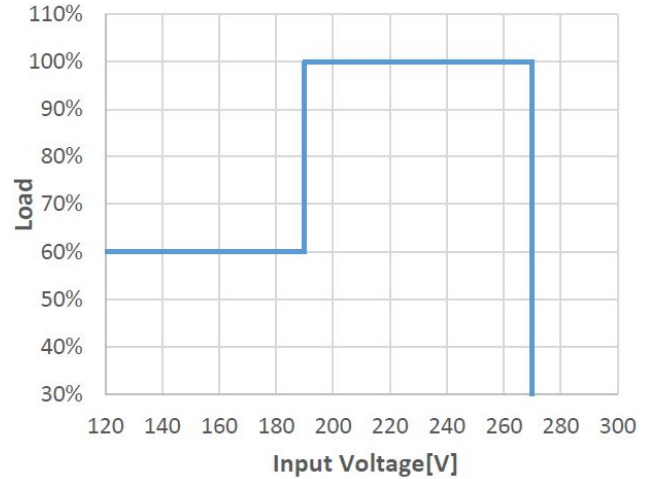

IT DALI 110 120 240 1A0 P7 Typical THD vs Load

IT DALI 120-240 1A0 P7 Typical Input Voltage vs Load

Typical Efficiency v Load 230 V 50 Hz

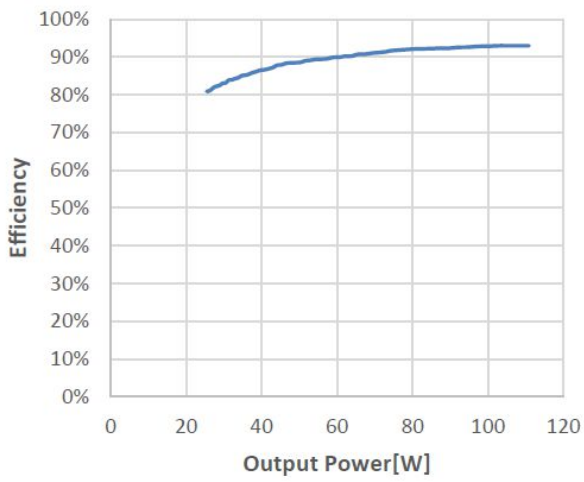

IT DALI 110 120 240 1A0 P7 Typical Efficiency vs. Load

Dimensions & weight

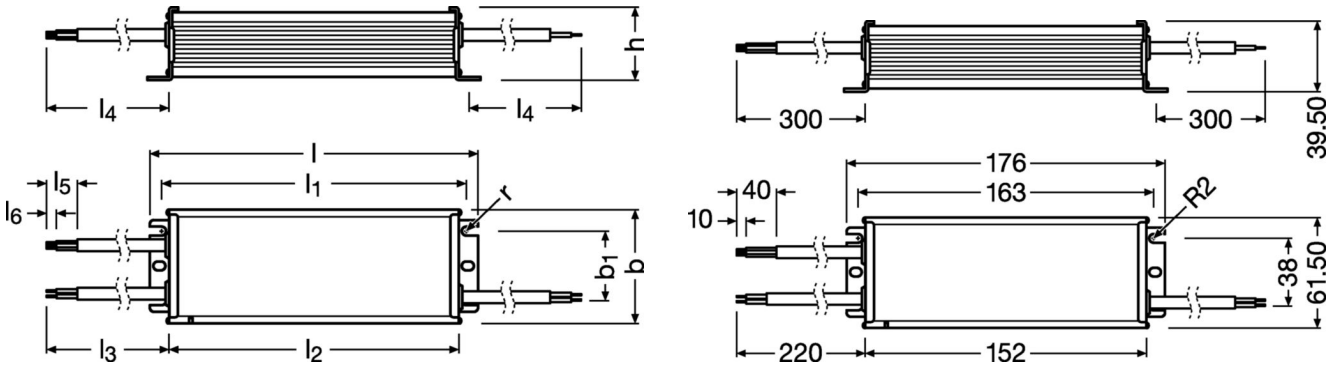

Product weight	650.00 g
Length	176.0 mm
Height	39.5 mm
Width	61.5 mm
Cable cross-section, input side	1.0 mm ²
Cable cross-section, output side	1.0 mm ²
Mounting hole spacing, length	163.0 mm
Mounting hole spacing, width	38.0 mm
Wire preparation length, input side	10 mm
Wire preparation length, output side	10 mm

Colors & materials

Casing material	Aluminium
-----------------	-----------

Temperatures & operating conditions

Ambient temperature range	-40...+60 °C
Max.housing temperature in case of fault	120 °C
Maximum temperature at tc test point	85 °C ¹⁾
Permitted rel. humidity during operation	5...95 % ²⁾
Temperature range at storage	-40...+85 °C

1) Measured on tc point indicated on the product label.

2) Non-condensing

Lifespan

ECG lifetime	50000 h / 100000 h ¹⁾
---------------------	----------------------------------

1) At maximum $T_c = 80^\circ\text{C}$ / 10% failure rate / At maximum $T_c = 70^\circ\text{C}$ / 10% failure rate

Capabilities

Max. cable length to lamp/LED module	2.0 m ¹⁾
Number of channels	1
Dimmable	Yes
Dimming interface	DALI-2 / AstroDIM
Dimming range	10...100 %
Overload protection	Yes
Short-circuit protection	Yes
Suitable for fixtures with prot. class	I / II
Constant lumen function	Programmable
LEDset	No
No-load proof	Yes

1) Output wires must be routed as close as possible to each other

Programming

Box programming	No
-----------------	----

Programmable features

AstroDIM	Yes
Configuration Lock	Yes
DALI-2 Luminaire Data	Yes ¹⁾
Driver Guard	No
Emergency Mode	No
MainsDIM	No
StepDIM	No

1) Acc. DALI part 251

Certificates & standards

Type of protection	IP67
Standards	Acc. to EN 61347-1 / Acc. to EN 61347-2-13 / Acc. to EN 55015 / Acc. to EN 61547 / Acc. to EN 61000-3-2 / Acc. to EN 61000-3-3 / Acc. to EN 60598-1 (ED.8) / Acc. to EN 62384
Approval marks – approval	CCC / CE / TISI / RCM / ENEC / UKCA / DALI-2 / IP67

Logistical data

Commodity code	85044083900
----------------	-------------

Environmental information

Information according Art. 33 of EU Regulation (EC) 1907/2006 (REACH)	
Date of Declaration	04-06-2024
Primary Article Identifier	4052899620339
Declaration No. in SCIP database	In work
SCIP_STATUS	In work
SCIP_ID	

Wiring Diagram

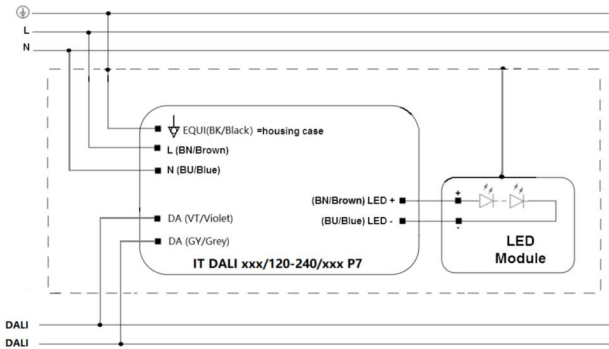

IT DALI 120 240 P7 Wiring Diagram

	Item	Value	Unit	Remarks
INPUT	Cable cross section	1.0	mm ²	L (Brown/BN), N (Blue/BU), EQUI (Black/BK)
	Wire preparation length	10	mm	
	Type of wire	Flexible three core cable		
	Lead length	300 ± 20	mm	
OUTPUT	Cable cross section	1.0	mm ²	LED+ (Brown/BN), LED- (Blue/BU)
	Wire preparation length	10	mm	
	Type of wire	Flexible two core cable		
	Lead length	300 ± 20	mm	
DIMMING	Cable cross section	0.3	mm ²	DALI+ (Violet/VT), DALI- (Grey/GY)
	Wire preparation length	10	mm	
	Type of wire	Flexible two core cable		
	Lead length	220 ± 20	mm	
CABLE LENGTH	LED+/LED-	< 2	m	

IT DALI 120 240 P7 Wiring Diagram

Ecodesign regulation information:

Intended for use with LED modules.

The forward voltage of the LED light source shall be within the defined operating window of the control gear in all operating conditions including dimming if applicable.

Separate control gear and light sources must be disposed of at certified disposal companies in accordance with Directive 2012/19/EU (WEEE) in the EU and with Waste Electrical and Electronic Equipment (WEEE) Regulations 2013 in the UK. For this purpose, collection points for recycling centres and take-back systems (CRSO) are available from retailers or private disposal companies, which accept separate control gear and light sources free of charge. In this way, raw materials are conserved and materials are recycled.

Additional product information

- Input voltage range: Nominal operation at 198 – 264Vac. Workable at 120 – 277Vac without safety issue (refer to [8] Typical Input Voltage vs. Load), but normal performance such as THD, EMI, lifetime etc are not guaranteed;
- Input voltage range: Nominal operation at 198 – 264Vac. Workable also at 120 – 198Vac without safety issue (refer to graph Typical Input Voltage vs. Load), but normal performance such as THD, EMI, lifetime etc are not guaranteed;
- Output overload/voltage protection: In case the input voltage of the load exceeds the output voltage range which is auto defined by output current setting of the driver ($V_o = P_o / I_o$), it automatically reduces the output current. The driver needs a power cycle to restart or DALI command with the correct load connected.
- Output short circuit protection: shut down of driver occur in case of output short circuit without damage to the unit.
- Output over load/voltage protection: In case the input voltage of the load exceeds the output voltage range which is auto defined by output current setting of the driver ($V_o = P_o / I_o$), it automatically reduces the output current. Auto-reversible without mains power on/off;
- No load protection: the driver automatically adjusts the output voltage to the maximum output voltage which is auto defined by output current setting of the driver ($V_o = P_o / I_o$) if no load is connected. The driver needs a power cycle to restart with the correct load connected.
- Over temperature protection: the driver is protected against temporary overheating by shutting down until the overheating eliminated; Auto-reversible when temperature back to normal;
- Disconnect the power before servicing. Terminal block is not included, installation must be performed by qualified person;
- The EQUI (housing) shall be connected to the heat sink of the LED module to improve the surge withstand capability of the system and EMI in critical luminaires.
- Not suitable to be mounted in ceiling corner
- The LED control gear cannot be abutted against or covered by normally flammable materials or used in installations where building insulation or debris is, or may be, present in normal use.
- The external flexible cable or cord of this driver cannot be replaced; if the cord is damaged, the driver shall be destroyed.
- The dimmer should fulfill at least basic insulation between control voltage and dimming circuit (for Australia and New Zealand).
- The minimum clearance distance from the top and sides of the controlgear to normally flammable building elements is $A=B=C=Min.10mm$, this clause does not apply when the LED driver is built-in the luminaires (for Australia and New Zealand).
- The startup time to reach the set output current is less than 2s.
- For further details please consult the application note;

Download Data

File		
Certificates	PDF	▶ EAC Certificate of OT products
Certificates	PDF	▶ ENEC Certificate of IT DALI P7
Certificates	PDF	▶ CCC certificate
CAD data	Compressed	▶ IT DALI 110 1A0 P7 STEP 300323
Mandatory Publications	PDF	▶ IT DALI P7 CE 4287284 120822
Mandatory Publications	PDF	▶ IT DALI P7 UK DoC 4287289 120822
User instruction	PDF	▶ User Instruction

Logistical Data

Product code	Product description	Packaging unit (Pieces/Unit)	Dimensions (length x width x height)	Volume	Gross weight
4052899620339	IT DALI 110/120-240/1A0 P7	Shipping carton box 15 Pieces	449 x 252 x 163 mm	18.44 dm ³	694.13 g

The mentioned product code describes the smallest quantity unit which can be ordered. One shipping unit can contain one or more single products. When placing an order, for the quantity please enter single or multiples of a shipping unit

Data privacy

This OSRAM driver can be configured using the Tuner4TRONIC software. This requires registering on www.myosram.com and downloading the Tuner4TRONIC software from the Internet. The Tuner4TRONIC software enables users to access and view the operational data of a luminaire or driver via the corresponding programming interfaces. A password key (Config Lock) must be set up in the driver via the Tuner4TRONIC software in order to control which users can access and view operational data. Follow the instructions for password setup. To grant an external person or company rights to access or view operational data, you can assign password keys. In this case, however, you are responsible for ensuring that the third party concerned takes notice of the information described here.

However, OSRAM can read out operating data from devices for maintenance and service purposes even when a password key has been assigned. In individual cases, OSRAM will also use its access rights in order to optimize or improve driver hardware and driver functions. In accordance with data privacy principles, any user of operating data (luminaire manufacturers, third parties with access rights) must ensure that personal data (e.g. name, address, location IDs) are only merged with the prior written consent of the person (end user) concerned. The respective user of the operating data is responsible for providing evidence of consent.

References / Links

* For more information on the multi-level guarantee and the terms and conditions of the guarantee visit <https://www.inventronics-light.com/multilevel-guarantees>

Accessories Optional

Product description	Accessory name	Accessory code
IT DALI 110/120-240/1A0 P7	DALI magic	▶ 6977078996907
IT DALI 110/120-240/1A0 P7	DALI magic	▶ 6977078997416

Disclaimer

Subject to change without notice. Errors and omission excepted. Always make sure to use the most recent release.